

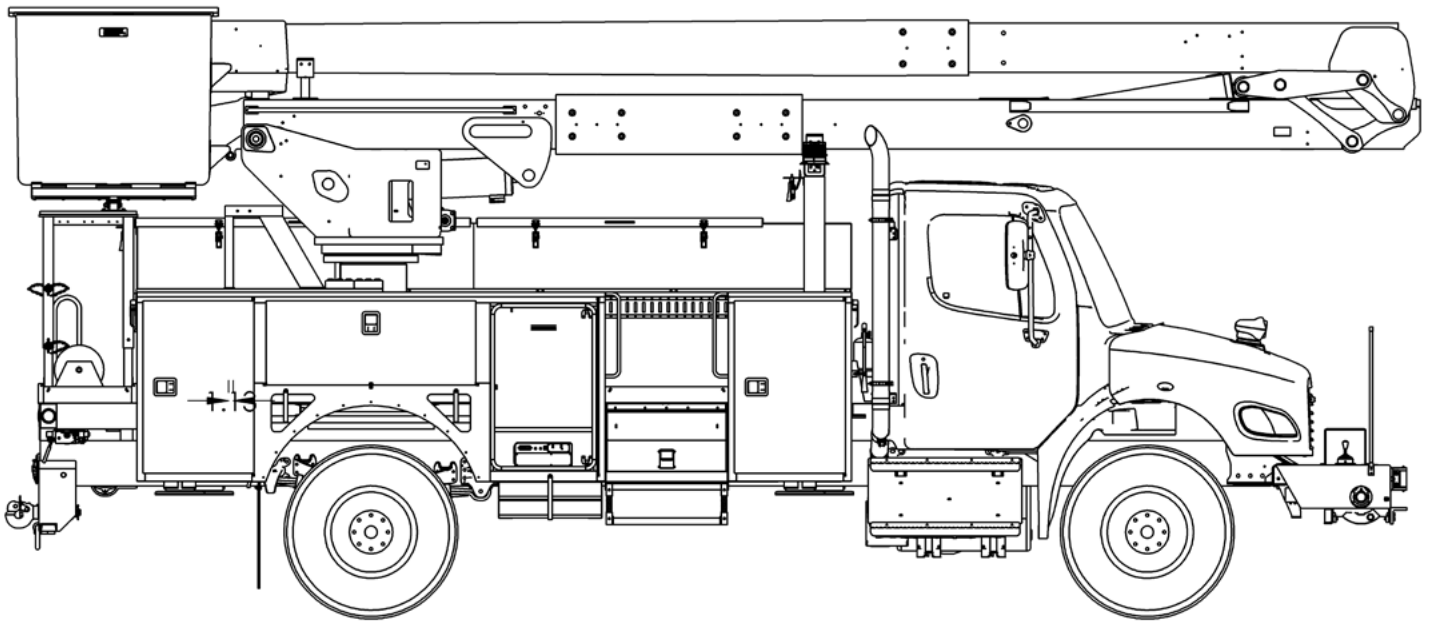

TECH TIPS

UPDATING THE SOFTWARE FILES IN MOTOTUNE

NO. 22



SERVICE CALL:
UPDATING THE SOFTWARE FILES IN
MOTOTUNE



MODEL(S):
COMPUTER WITH MOTOTUNE
INSTALLED
INTERNET CONNECTION



TOOLS NEEDED:
HYPOWER™ 408V SYSTEMS

TEREX UTILITIES TECHNICAL SUPPORT TEAM

PHONE: 1-844-TEREX4U (1-844-837-3948) | EMAIL: UTILITIES.SERVICE@TEREX.COM



DANGER

Failure to obey the instructions and safety rules in the appropriate Operator's Manual and Service Manual for your machine will result in death or serious injury.

Many of the hazards identified in the Operator's Manual are also safety hazards when maintenance and repair procedures are performed.

DO NOT PERFORM MAINTENANCE UNLESS:

- ✓ You are trained and qualified to perform maintenance on this machine.
- ✓ You read, understand and obey:
 - manufacturer's instructions and safety rules
 - employer's safety rules and worksite regulations
 - applicable governmental regulations
- ✓ You have the appropriate tools, lifting equipment and a suitable workshop.

The information contained in this Tech Tip is a supplement to the Service Manual. Consult the appropriate Service Manual of your machine for safety rules and hazards.



TECH TIP 22 | RELEASED 03.07.2022 | VERSION 1.0
©TEREX UTILITIES. ALL RIGHTS RESERVED

CONTENTS

TECH TIP #22

TOC

4

| *Download the required files*

STEP 1 - STEP 3

6

| *Copy the files into the required folder*

STEP 5 - STEP 6

STEP 1

Download the latest software files.

STEP 2

Extract all the files from the zip folder.

STEP 3

Open the ECUFiles folder located on the C: drive. The contents of the folder should be similar to the image shown below.

C:\ECUFiles

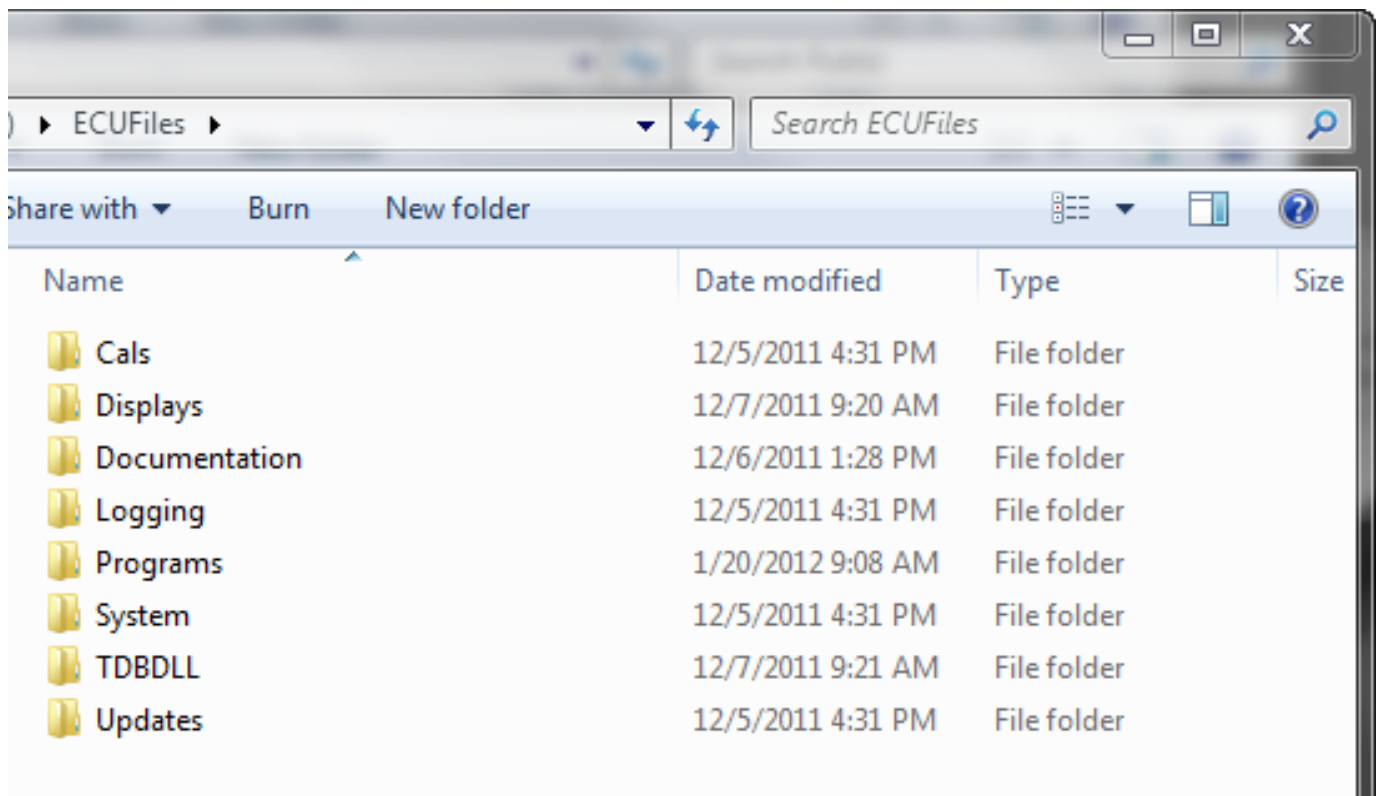

STEP 4

Keeping the ECUFiles window open, double-click on the extracted folder created in Step 2. The contents will look similar to the image below.

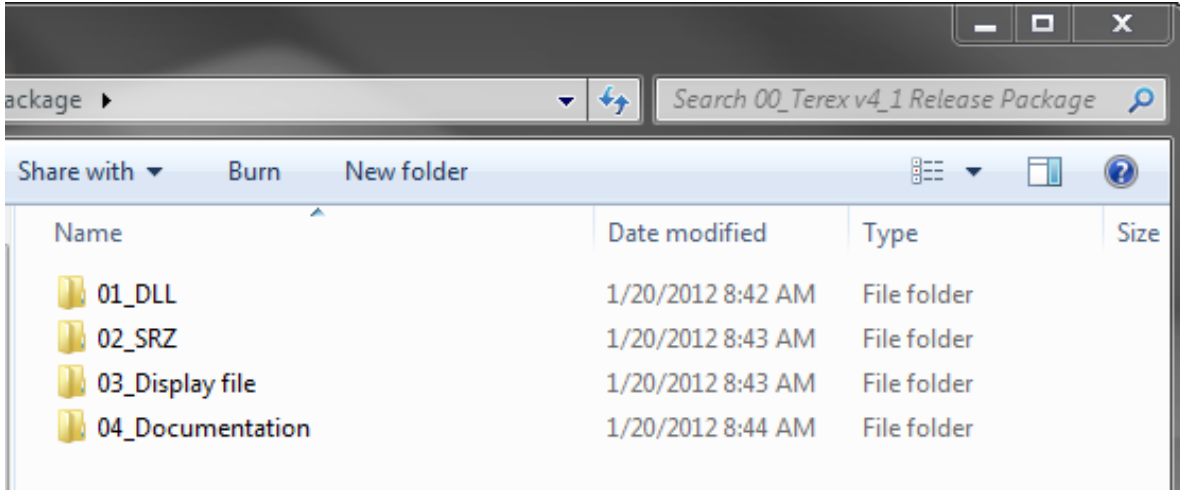

STEP 5

Double-click the 01_DLL folder to open it.

Note: Current file names may be different than those displayed.

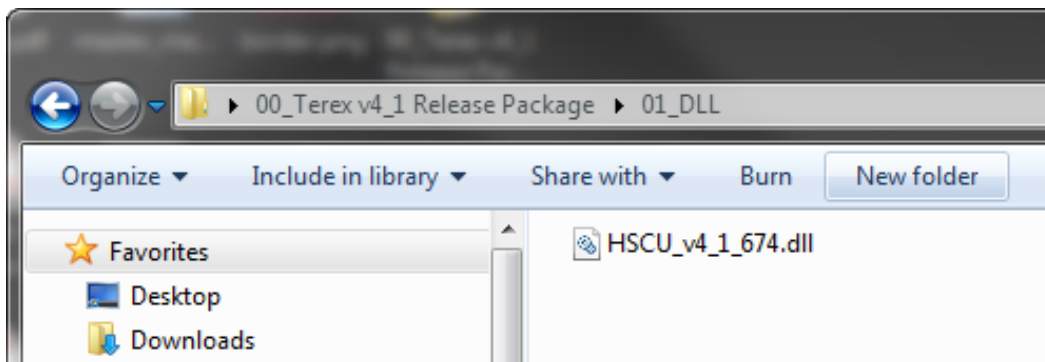

STEP 5 (CONTINUED)

In the ECUFiles window, double-click on the TBDDLL folder to open it.

Copy all the files from the 01_DLL folder into the TBDDLL folder by dragging the files from the 01_DLL to the TBDDLL folder. Note: If you are prompted to overwrite any files, click on “Yes”.

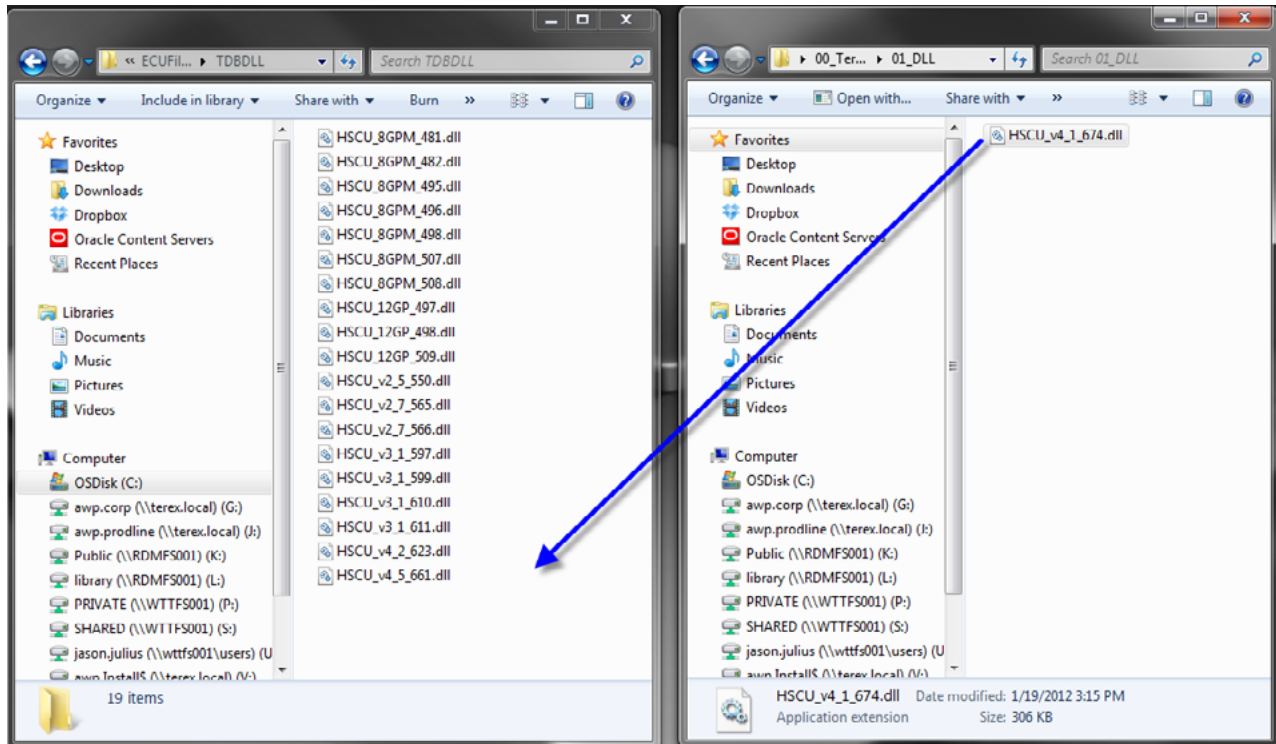

STEP 6

Click the back button in both windows so you can again see the 01_DLL and the TBDDLL folder names.

STEP 7

Double click on the 02_SRZ and the Programs folders in their respective windows to view the folder contents.

In the Programs folder:

- If there is an archive folder inside the Programs folder, drag all the files currently in the Programs folder into the archive folder
- If no archive folder exists, right click in an empty area inside the folder and select New Folder from the menu. Name the folder archive and then place all the files currently in the Programs folder into the archive folder.

The images below show how the Programs folder looks before and after the files are archived.

Once the old files have been placed in the archive, copy the new files from 02_SRZ into the Programs folder.

Click the back button in both windows so you can again see the 02_SRZ and the Programs folders.

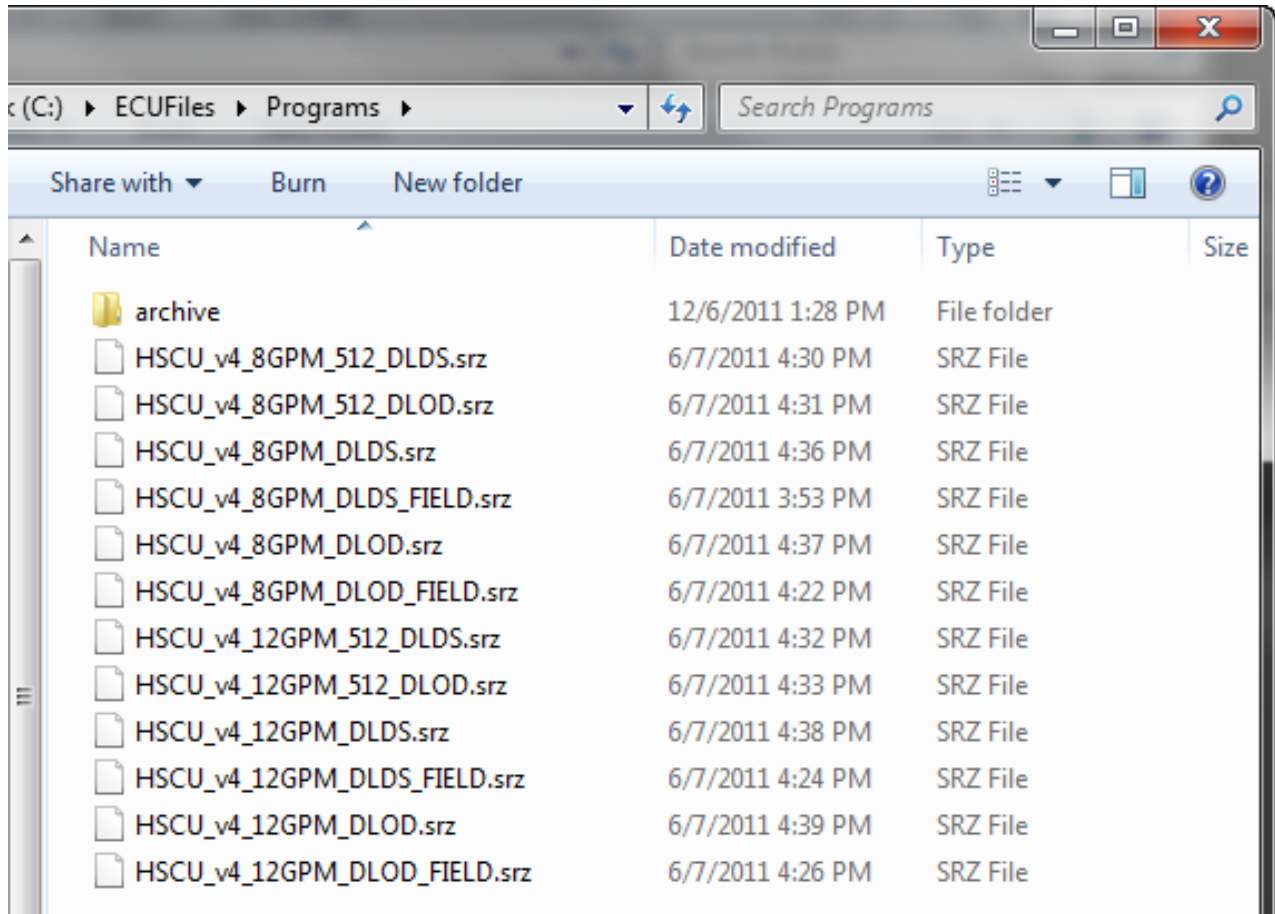

BEFORE

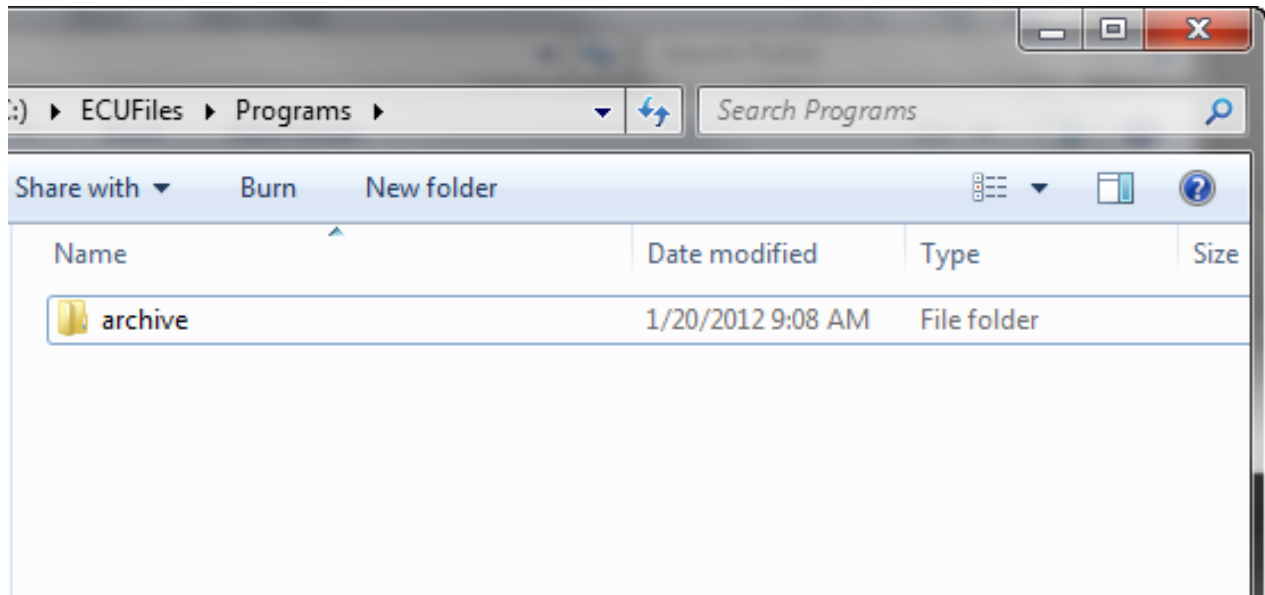

AFTER

STEP 8

Double-click the 03_Display File and the Display folders to open them in their respective windows.

Delete any existing files in the Display folder.

Copy the files from the 03_Display File to the Display folders.

Click the back button in both windows so you can again see the 03_Display File and the Display folders.

STEP 9

Finally, double-click the 04_Documentation and Documentation folders in their respective windows.

Note: The Documentation folder is not automatically created when Mototune is installed. If the Documentation folder does not exist in the ECUFiles window, right-click in the window and add a new folder named Documentation.

Delete any files currently in the Documentation folder.

Copy the new files from the 04_Documentation folder into the Documentation folder.

STEP 10

Close both of the windows, the updates are completed and ready for use.



FOR FURTHER ASSISTANCE,
CONTACT THE TEREX UTILITIES TECHNICAL SUPPORT TEAM
PHONE: **1-844-TEREX4U (1-844-837-3948)** | EMAIL: **UTILITIES.SERVICE@TEREX.COM**
